

Varenummer: 201580M510MT
Beskrivelse: E+G Bolt GN 1580-M5-10-MT-H
Hygiejnisk design

Mål

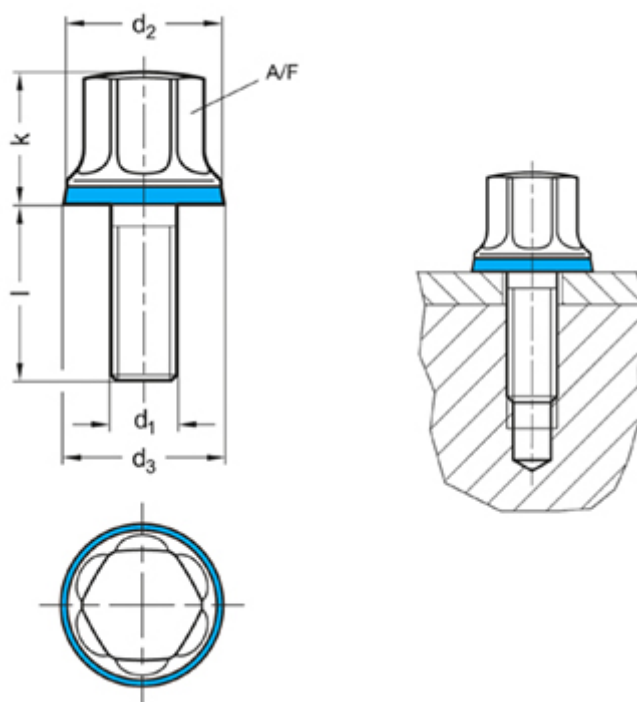

d1	= M 5
d2	= 12
d3	= 12.8
k	= 10
L	= 10
t min	= -
Vægt i (g)	= 6